

# Data Sheet



Article number: 72009090032

Description: Gear Head SP90B I=90  
Pinion input

## Measures

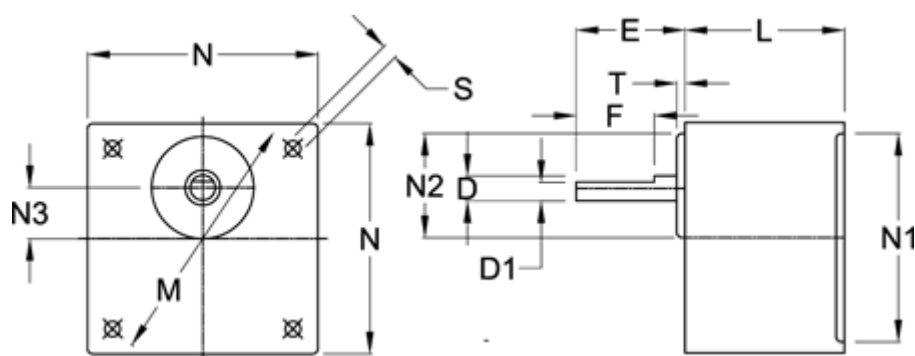

D = 12	N2 = 38
D1 = 9.5	N3 = 18
E = 35	S = 4xø6,5
F = 25	T = 5
L = 60	
M = 104	
N = 90	
N1 = 83	